

BEST IN CLASS RADIO REMOTE CONTROLS

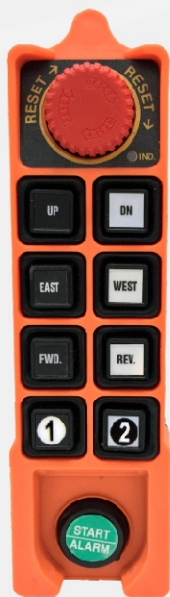

TRANSMITTER



SKY-401

TRANSMITTER

The rugged design of the transmitter allows the possibility to incorporate 8 single depression push buttons as per requirement. Transmitter status can be monitored via LED indication available on the transmitter. Body made from thermoplastic material provides resistance to harsh industrial environments. Operates with 2 AA batteries.

RECEIVER

The receiver of the system contains 18 potential free contact relays (16 + Start + Alarm) which can be configured as per the requirement. The receiver also contains a feedback module which continuously monitors the internal circuitry and enables the user to check the Receiver status via the LED on the receiver.

RECEIVER



TECHNICAL SPECIFICATIONS

Number of commands	8 + Start/Stop + Alarm
Hamming Distance	>=6
Response Time	<24ms
Active Emergency Response Time	<24ms
Operating Range	100 meters

TRANSMITTER

Number of push buttons	8 + Start/Stop + Alarm
Operating Frequency	UHF (310.00 to 336.00 Mhz)
Channel Spacing	25KHz
Modulation	FM
RF Power Output	10mW
Coding Key	FFSK
Transmitting Power Consumption	<15mA
Standby Power Consumption	<1mA
Battery Type	2 AA Size Alkaline Batteries
Operating Temperature	-20 Degree C to +70 Degree C
Transmitter Approx Weight	275 grams (without battery)
Dimensions	163mm (H) x 49mm (W) x 45mm (B)
Protection Rating	IP 65

RECEIVER

RF Sensitivity	0.6mV
Number of Potential Free Contacts	16 + Start/Stop + Alarm
Relays	Resistive Load : 5A at 230VAC or 30VDC
Power Requirements	110VAC/220VAC
Display	By means of LEDs
Maximum Consumption	100VA
Dimensions	250mm(H) x 235mm(B) x 100mm(W)
Weight	Approx 1.4 Kg
Protection Rating	IP 65

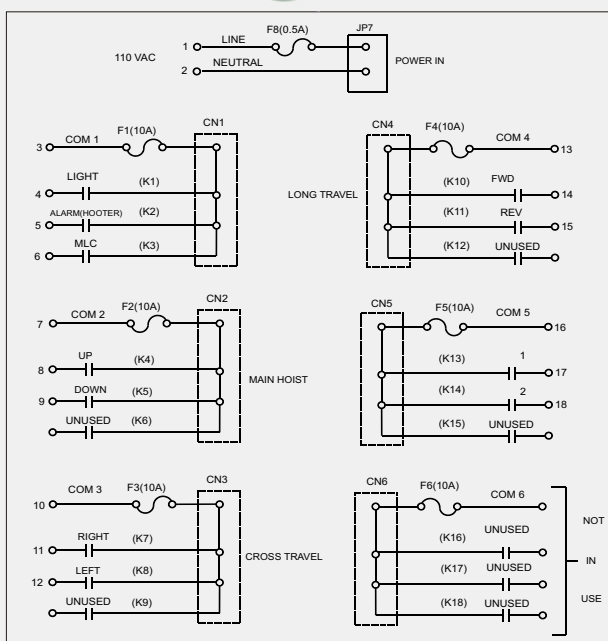

SPEED-O-CONTROLS PVT. LTD.

H. O. Unit - I: C-15/16, Nand Jyot Industrial Estate,
Andheri - Kurla Road, Mumbai - 400072
Tel : (022) 42469700-30, (022) 28518512-3-4,
Fax : (022) 42469797/ 28518516,
E-mail : sales@socgroup.in

Unit - II: Plot No. 4912, G. I. D. C.,
Phase IV, Vatva, Ahmedabad - 382445
Tel.: (079) 40083201/2/3/4,
Fax : (079) 25841056,
E-mail : sales.amd@socgroup.in

Visit us at : www.socremote.com
: www.speedocontrols.com